

NASA Technical Memorandum 86220

A Study of the Dynamics of the ITCZ in a Symmetric Atmosphere-Ocean Model

J. G. Charney, E. Kalnay,
E. Schneider, and J. Shukla

JUNE 1988

(NASA-TM-86220) A STUDY OF THE DYNAMICS OF
THE INTERTROPICAL CONVERGENCE ZONE (ITCZ) IN
A SYMMETRIC ATMOSPHERE-OCEAN MODEL (NASA)
24 p CSC1 04B

N88-26005

Unclas

G3/47 0147101

NASA

NASA Technical Memorandum 86220

**A Study of the Dynamics
of the ITCZ in a Symmetric
Atmosphere-Ocean Model**

J. G. Charney
*Massachusetts Institute of Technology
Cambridge, Massachusetts*

E. Kalnay
*Goddard Space Flight Center
Greenbelt, Maryland*

E. Schneider and J. Shukla
*University of Maryland
College Park, Maryland*



National Aeronautics
and Space Administration

Scientific and Technical
Information Division

1988

PREFACE

This unfinished manuscript was written shortly after the Symposium on Monsoon Dynamics held in New Delhi, in December of 1977. It was not completed at that time because the authors were not satisfied with the large transient component in the meridional circulation in some of the experiments. Later, after two of the co-authors (E. Kalnay and J. Shukla) left MIT, the work on the manuscript was discontinued. Further studies with an uncoupled symmetric atmospheric model were subsequently performed and published by Goswami *et al.* (1984) who found that the lack of convergence was due to the model formulation of the interaction between clouds and radiation. We believe, however, that the results contained in the paper, especially in the case of the coupled ocean-atmosphere model which were less affected by the transient oscillations, are still of interest. The purpose of this Technical Memorandum is to make these results available to the scientific community.

1. INTRODUCTION

In this paper we present preliminary numerical calculations of the circulation of a zonally symmetric interactive atmosphere-ocean model. The zonally averaged circulation is the dominant factor in the meridional transport of heat, momentum and water vapor in the tropics, and it plays an important role even at higher latitudes (Oort and Rasmussen, 1970). This indicates that the study of a hypothetical axisymmetric circulation, in which asymmetric eddies generated by orographic and thermal forcing and by flow instabilities are suppressed by the assumption of axisymmetry, may be relevant to the understanding of the tropical circulation and can be used as a basic unstable steady state to study the characteristics of transient disturbances at higher latitudes.

Schneider (1977) and Schneider and Lindzen (1977) developed simplified linear and nonlinear axisymmetric models of the atmosphere. They found that when friction and heating due to cumulus convection were included, the tropical circulation was qualitatively similar to the observed zonally averaged circulation. When nonlinear advection of angular momentum was included in the symmetric model, they obtained a three-cell meridional structure, with the Intertropical Convergence Zone (ITCZ) forming at the sea surface temperature maximum (the Equator in their case), surface easterlies and westerlies at the observed latitudes, and a Ferrell cell in mid-latitudes. They concluded that in the real atmosphere the large-scale eddy flux divergences do not modify the basic state axially-symmetric circulation qualitatively.

The opposite conclusion had been previously reached by Hunt (1973) who used a symmetric version of the GFDL general circulation model (Manabe and Hunt, 1969) to compute a fully nonlinear axisymmetric solution. His results were very different from the observed zonally averaged circulation. He obtained westerly winds throughout the atmosphere, except in shallow surface layers at mid and high latitudes. The maximum winds ($\sim 110 \text{ m/sec}^{-1}$) were obtained in the equatorial stratosphere. From his results, Hunt concluded that the effect of the suppressed eddy flux divergence is essential in determining the characteristics of the zonally averaged circulation. However, Hunt's results do not seem to be reliable, because the zonal winds he obtained were independent of the meridional circulation (weak Hadley cells in both his moist and dry experiments) and were strongly sensitive to the intensity of the parameterized horizontal eddy viscosity. Therefore, his conclusions may be unwarranted. It is still necessary to obtain a nonlinear symmetric solution with a model free from the essentially artificial horizontal viscosity.

The position and intensity of the ITCZ depends on the distribution of land and sea (Palmen and Newton, 1969). Charney (1971) has suggested that over the oceans an ITCZ at the Equator is unstable to lateral displacements. If it is displaced to the North, say, the induced surface easterlies at the Equator will result in upwelling and lowering the sea surface temperature, preventing the ITCZ from moving back to the Equator. At the same time cyclonic shear will be generated across the ITCZ from the convergence of rings of air with different angular momentum, and this will enhance frictional convergence at the ITCZ.

To investigate the nature of the coupled tropical circulation, and also other phenomena such as the monsoon circulation, we have constructed simple axisymmetric models of the ocean and the atmosphere, by modifying Kalnay-Rivas (1973) axisymmetric Boussinesq model for Venus and symmetricizing the general circulation model (GCM) of the Goddard Institute for Space Studies (GISS). An axisymmetric ocean-model is less relevant to the Earth than an axisymmetric atmospheric model, due to the presence of continents. However, the solutions that we have obtained are instructive, both as a study of the circulation of a hypothetical ocean covered Earth, and a first approximation of the coupled ocean-atmosphere circulation in the middle of large oceans such as the Pacific, where observations show a marked zonal symmetry.

We present in section 2 a brief description of the models. Preliminary calculations have been performed with the ocean model driven by smoothed, annually averaged, observed heat fluxes and zonal wind stresses. The atmospheric model was also integrated with an assumed constant sea surface temperature distribution. These calculations, as well as an integration of the coupled models in which the Sun is assumed to be at the Equator (permanent equinox) are presented in section 3.

Additional experiments including the effect of topography and varying solar declination will be presented in a later paper.

2. DESCRIPTION OF THE MODELS

The coupled model (Fig. 1) consists of an atmospheric model (described in section 2.1) which is driven by solar radiation, and an ocean model (described in section 2.2) driven by surface heat flux and wind stress. The atmospheric model predicts the zonal (u) and meridional (v) wind components, the temperature T, mixing ratio q and surface pressure p_s . From these quantities the outgoing long-wave radiation, surface wind stress and net heat flux (including short and long wave radiation, and latent and sensible heat fluxes) are derived through suitable parameterizations (Sommerville *et al.*, 1974). The surface heat flux is used to compute the ground temperature changes in the continental regions. The ocean model predicts the density ρ and horizontal current components u and v. The sea surface temperature T_s derived from the density by a simple linear law is returned to the atmospheric model. In the coupled model the ice phase is crudely simulated by setting the minimum sea surface temperature equal to 0°C.

In the numerical integrations presented in this paper we have attempted to obtain equilibrium solutions corresponding to a fixed solar declination. Since the relaxation time for the deep ocean is much longer than that of atmosphere, we have advanced the atmospheric model with time steps of 10 minutes and the ocean model with time steps of 12 hours. Approximately steady state solutions for the coupled model are obtained after about 3 months of atmospheric integration and about 25 years of oceanic integration.

2.1 Symmetric Atmospheric Model

This model is an axially symmetric version of the 9-level global equation model on σ -coordinates of the Goddard Institute for Space Studies (Sommerville *et al.*, 1974). The modifications made on the GISS model, besides setting the longitudinal derivatives to zero, include the replacement of the climatological values of the temperatures above 10 mb used in the calculation of long wave radiation by a constant temperature of 200°K, and the elimination of the daily solar cycle by setting the zenith angle equal to the average zenith angle over one day period. The vertical eddy viscosity and diffusivity coefficients in the interior of the atmosphere have been increased from approximately $10^3 \text{ cm}^2 \text{ sec}^{-1}$, and the model contains no horizontal diffusion or viscosity. In the uncoupled version of the atmospheric model, the sea surface temperature is prescribed and assumed to be constant.

2.2 Symmetric Ocean Model

This is a modified version of a Boussinesq axisymmetric model for Venus (Kalnay-Rivas, 1973), in which, for simplicity we have used a linear relationship between density and temperature and neglected the effects of salinity.

The governing equations are

$$u_t + v u_\phi / a + w u_z - (f + v \tan\phi/a)v = \nu_v u_{zz} \quad (2.1)$$

$$v_t + v v_\phi / a + w v_z + (f + u \tan\phi/a)u = p_\phi(a\rho_0) + \nu_v v_{zz} \quad (2.2)$$

$$(v \cos\phi)_\phi / (a \cos\phi) + w_z = 0 \quad (2.3)$$

$$0 = -p_z / \rho_0 - g \rho / \rho_0 \quad (2.4)$$

$$\rho_t + v \rho_\phi / a + w \rho_z = \kappa_H (\rho_\phi \cos\phi)_\phi / (a^2 \cos\phi) + \kappa_v \rho_{zz} \quad (2.5)$$

$$\rho = \rho_0 [1 - (T - T_0)/T_m] \quad (2.6)$$

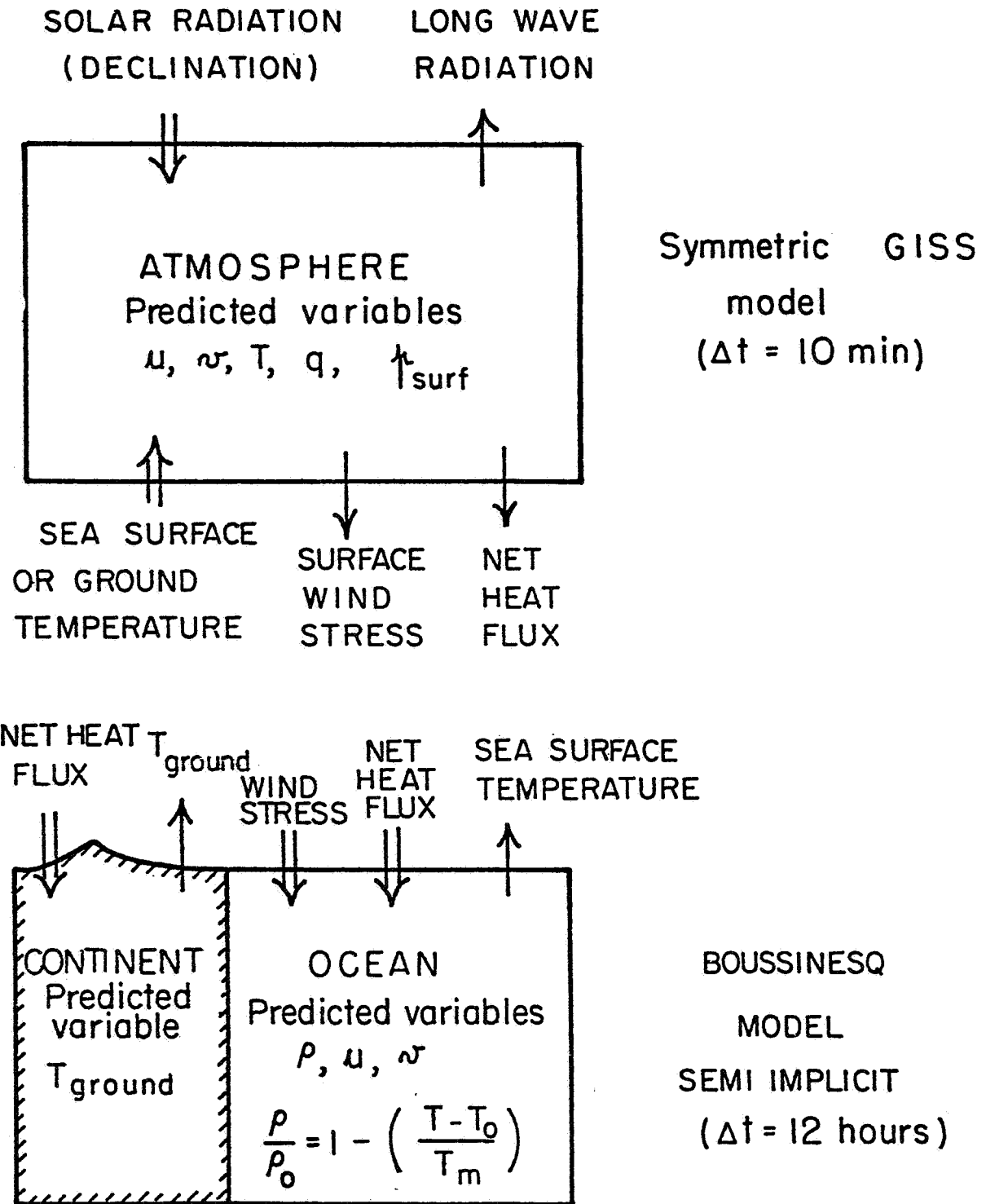

Fig. 1: Schematic representation of the coupled atmosphere-ocean models. Double arrows represent input parameters, and single arrows output parameters.

$T_0 = 273^\circ\text{K}$ and $\rho_0 = 1 \text{ g cm}^{-3}$ are the reference temperature and density, respectively. We have used standard nomenclature for the other variables. The boundary conditions are

$$\text{at } z=0: \nu_v u_z = \tau_0^{(x)} / \rho_0; \nu_v v_z = \tau_0^{(y)} / \rho_0; w = 0; \kappa_v T_z = F_0(\phi), \quad (2.7)$$

$$\text{and at } z = -H: u = v = w = 0; \kappa_v T_z = 0 \quad (2.8)$$

At latitudes ϕ_0 where we assume a continental wall, we have also assumed

$$v = 0; \kappa_H T_\phi = 0 \quad \text{at } \phi = \phi_0 \quad (2.9)$$

Here τ_0 represents the surface wind stress, ν_0 and κ_v are the vertical coefficients of eddy viscosity and diffusivity which we have taken as $1 \text{ cm}^2 \text{ sec}^{-1}$, and F_0 is the net surface heat flux. Horizontal diffusion is assumed to represent the effect of baroclinic mid-ocean eddies which are not expected to produce an appreciable net transport of momentum. Therefore we have not included horizontal viscosity and have taken the horizontal diffusivity $\kappa_H = 10^8 \text{ cm}^2 \text{ sec}^{-1}$, a value not unrealistic for eddies with scales of the order of 100 km and velocities of a few cm sec^{-1} .

A meridional mass stream function ψ is defined from (2.3) so that $v \cos \phi = -\psi_z$, $w \cos \phi = \psi_\phi/a$ and the meridional transports are given by $2\pi a \psi = (4 \times 10^9 \text{ cm})\psi$.

The numerical scheme is similar to that described in Kalnay-Rivas (1973) except that the Coriolis term is computed implicitly so that the model is stable using time steps of 12 hours. The vertical grid is stretched (Kalnay-Rivas, 1972) giving maximum resolution at the top and bottom of the model so that for an ocean depth of $H = 4 \text{ km}$ and 18 vertical levels the top and bottom layers are only 30 m thick.

The model includes a mechanism of convective adjustment which is applied in regions of static instability. A modified version of the RT mixed layer model (Thompson, 1976) has been incorporated as an optional procedure. Whenever the Richardson number $R_i = -g/\rho_0 \partial\rho/\partial z / [(\partial u/\partial z)^2 + (\partial v/\partial z)^2]$ computed at the bottom of the mixed layer, is smaller than one, a new layer is incorporated into the mixed layer. However, since the integrations are not qualitatively modified by the introduction of the mixed layer, the results here have been computed without it. In fact, Thompson has shown that his mixed layer model with constant depth, which is implicit in the ocean model, produced results similar to the RT mixed layer model.

3. RESULTS

3.1 Uncoupled Atmospheric Experiments

In order to test the model, we performed several experiments with the uncoupled atmospheric model keeping the sea surface temperature constant. We also wished to compare our results with those derived by Schneider (1977) and Schneider and Lindzen (1977) from a simplified model.

Except when stated otherwise, the experiments described below were started from a dry isothermal (280°K) atmosphere in a state of rest.

Case I: No condensation, permanent equinox, ocean covered surface

An experiment was conducted in which water vapor acted as a passive constituent, with a constant mixing ratio of 3 g Kg^{-1} interacting only through long wave radiation, and with an ocean covered surface with temperature $T = 300^\circ\text{K} - 50^\circ \text{K} \sin^2 \phi$. In this experiment the model converged to an exactly steady state solution. Fig. 2a shows the steady state mass stream

function obtained after about 4 months of integration. The solution is symmetric with respect to the Equator; in each hemisphere there is a single Hadley cell extending to high latitudes, with a mass flux of $8 \times 10^{13} \text{ g sec}^{-1}$, and a small indirect cell at low levels at the Equator. There are weak and wide ITCZs centered at about 8° latitude North and South. The field of zonal velocities (Fig. 2b) implies that friction in the interior of the model atmosphere is important in the angular momentum budget. A ring of air started at rest at the equator and moved inviscidly to 30° latitude would attain zonal velocities in excess of 100 m sec^{-1} , about three times the value found in the model. Weak easterlies occur at the Equator extending at the surface up to 40° latitude, and westerlies are found elsewhere, with a maximum of about 35 m sec^{-1} at the top of the model near 50° .

Case II: Condensation, ocean covered surface, permanent equinox

In this case condensation, evaporation and cumulus convection were included, as in the standard GISS model. The ocean temperature was fixed at $T = 30^\circ\text{K} - 40^\circ\text{K} \cdot \sin^2\phi$, and the sun was assumed to be at the Equator.

In this case, as well as in Cases III and IV discussed below, the solution showed no tendency towards a steady state, especially in the meridional circulation. Whereas the time averaged solution was reasonably well behaved, in the meridional circulation transients of small latitudinal scale with periods of the order of time step and amplitudes larger than the time mean were present throughout integration. The increase in vertical diffusion mentioned in Section 2.1 had no effect on these transients. The lack of convergence was associated with the presence of moisture, since the model converged in the dry Case I¹.

Even though the boundary conditions were symmetric with respect to the Equator, the time averaged stream function solution is very asymmetric, with a strong ITCZ occurring at about 8°N and a weaker convergence zone at 2°N (Fig. 3a). (The fact that the ITCZ occurs in the northern hemisphere is fortuitous and due to random round-off errors.) The maximum westerly winds, of 45 m sec^{-1} occur at about 28°N and 28°S , and surface easterlies extend to about 25° , with small regions of surface easterlies at higher latitudes (Fig. 3b).

Case III: Condensation, land north of 12°N , permanent equinox

In this case, land of 10 m elevation, 14% albedo and ground wetness of 0.6 was assumed to exist north of 12°N , and the sun was assumed to be at the Equator. In this case there is also a single ITCZ centered at 6°S over the southern hemisphere, in which sea surface temperatures are relatively warmer than the corresponding land temperatures. The mass flux of the northern Hadley cell is $30 \times 10^{13} \text{ g sec}^{-1}$. Maximum westerlies of 45 m/s occur at 30°N (Figs. 4a, b).

Case IV: Condensation, land north of 12°N , permanent solstice

This case was started from the quasisteady solution of Case III as initial condition, but the sun was assumed to be at 23.5°N (permanent summer solstice in the northern hemisphere). In this case the ITCZ occurs at about 24°N , the latitude of maximum insolation, but there is a secondary convergence zone at 6°N (Fig. 5a). There are easterlies between 10°S and 20°N with a maximum of 25 m sec^{-1} at 10°N (Fig. 5b). The maximum westerlies occur at 30°N (50 m sec^{-1}) and 32°S (over 70 m sec^{-1}).

3.2 Uncoupled Ocean Experiments

We computed several steady state solutions of the ocean model. The driving surface heat flux and wind stress are based on the annually averaged observed data by Oort and Von der Haar (1976). This data was smoothed (Fig. 6) and modified in order to enforce zero net heat flux and zero net torque over the globe. The depth of the ocean in these calculations was taken as 2 km in order to save integration time.

¹Goswami *et al.* (1984) later found that it was due to the model formulation of the interaction between clouds and radiation. Without this interaction steady or slowly changing solutions were found.

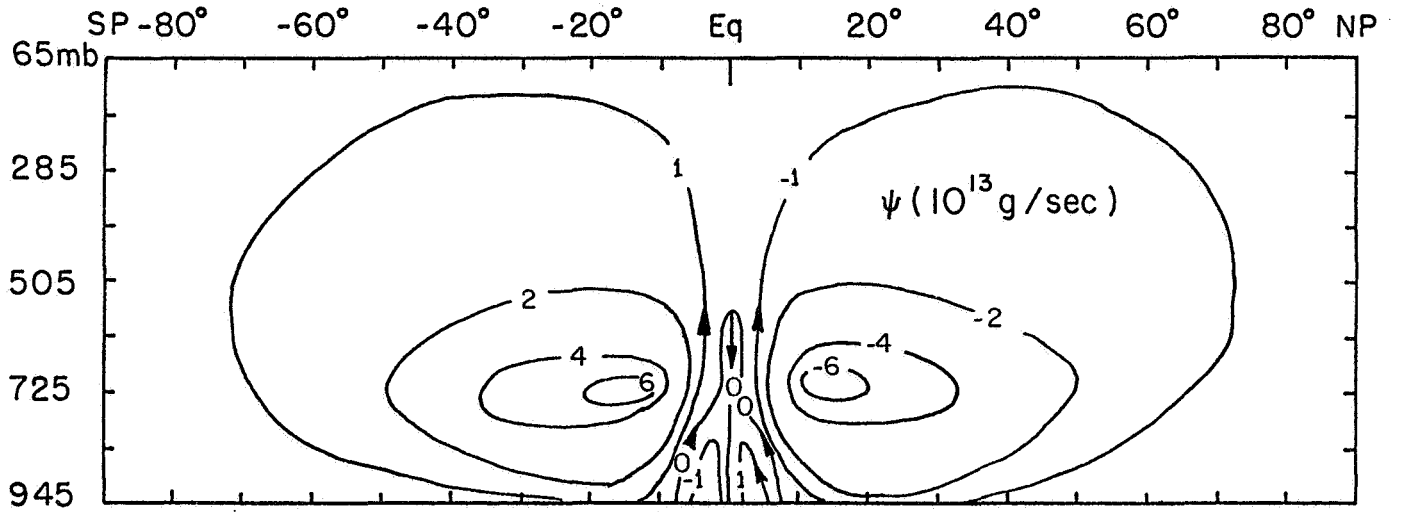

(a)

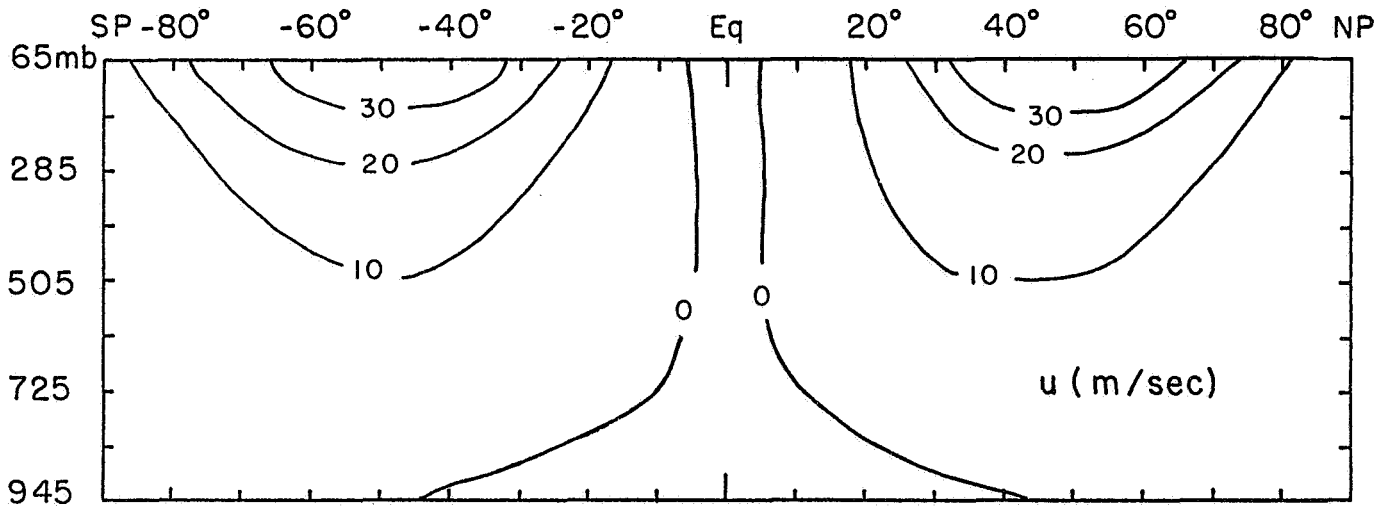

(b)

Fig. 2: Steady state atmospheric solution corresponding to the uncoupled case I (no condensation, permanent equinox, ocean covered surface). a) meridional mass stream function; b) zonal velocity.

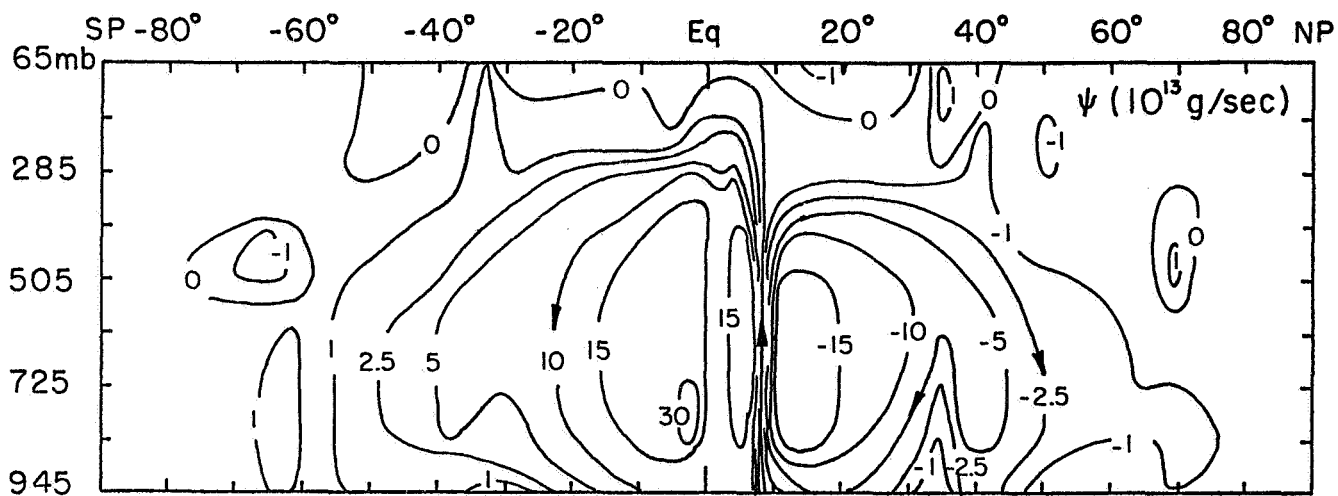

(a)

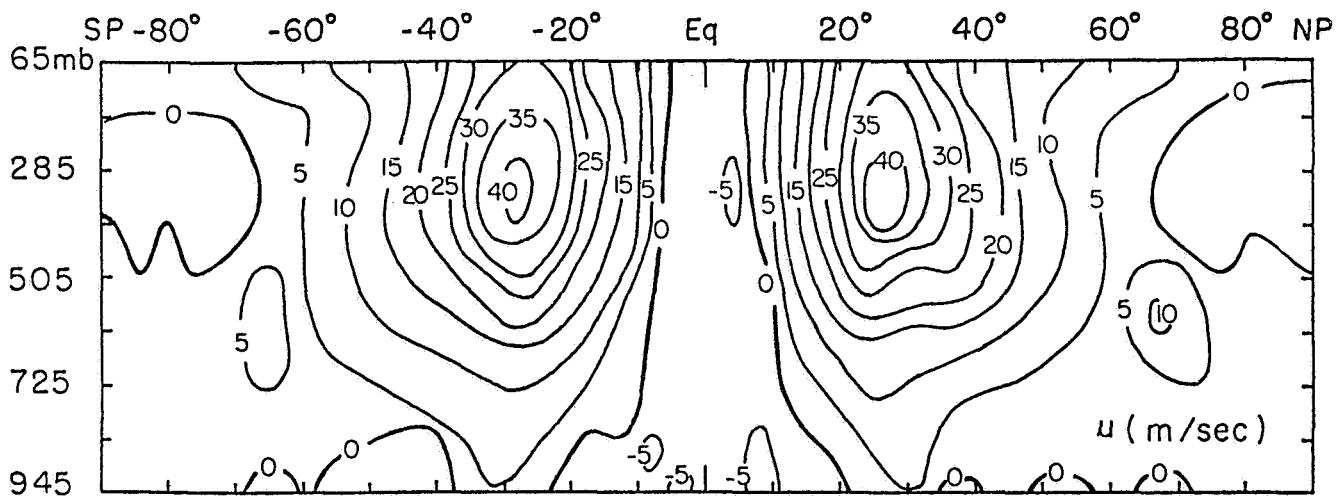

(b)

Fig. 3: Same as Fig. 2 except for case II (condensation, permanent equinox, ocean covered surface).

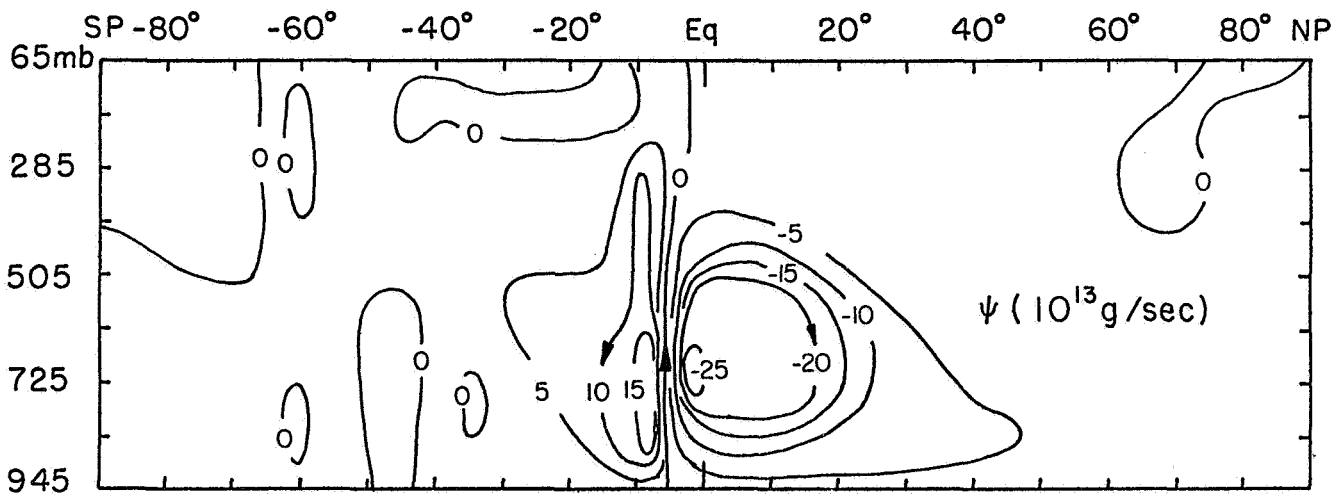

(a)

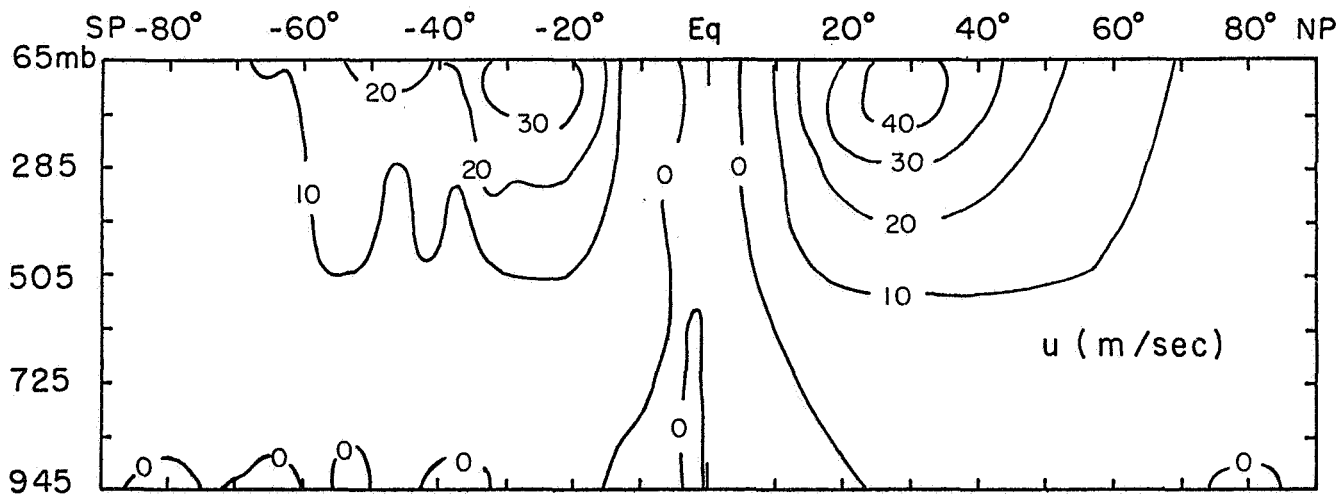

(b)

Fig. 4: Same as Fig. 2, except for case III (condensation, permanent equinox, land north of 12°N).

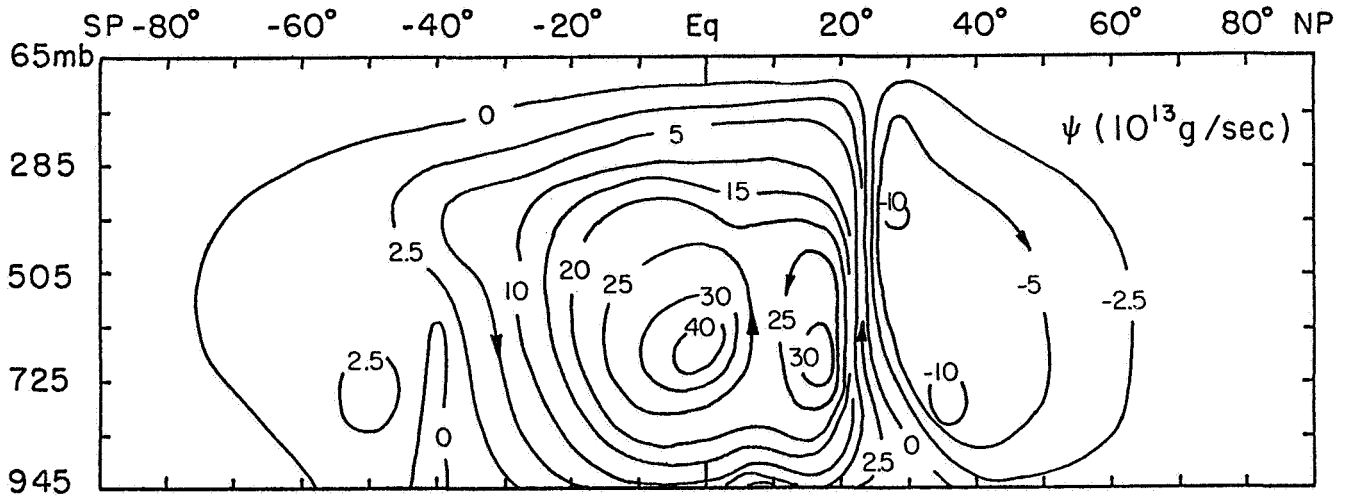

(a)

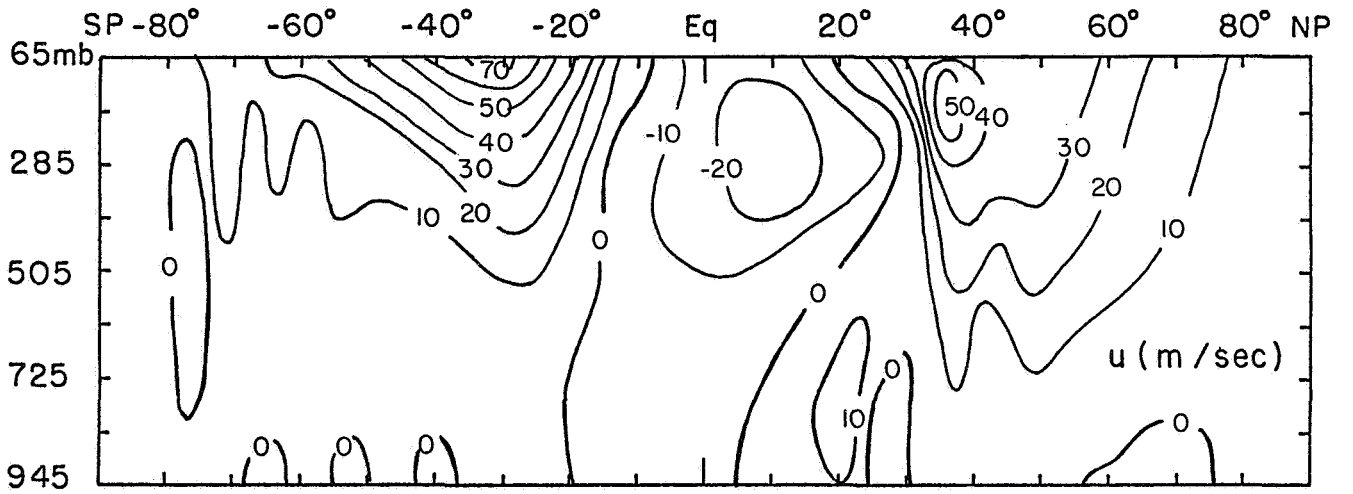

(b)

Fig. 5: Same as Fig. 2, except for case IV (condensation, permanent summer solstice, land north of 12° N).

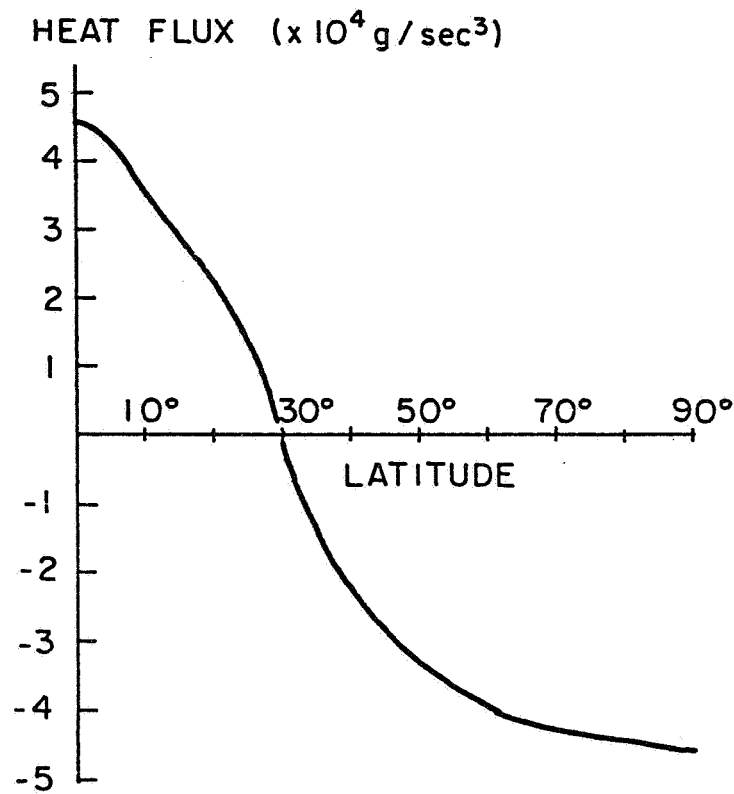
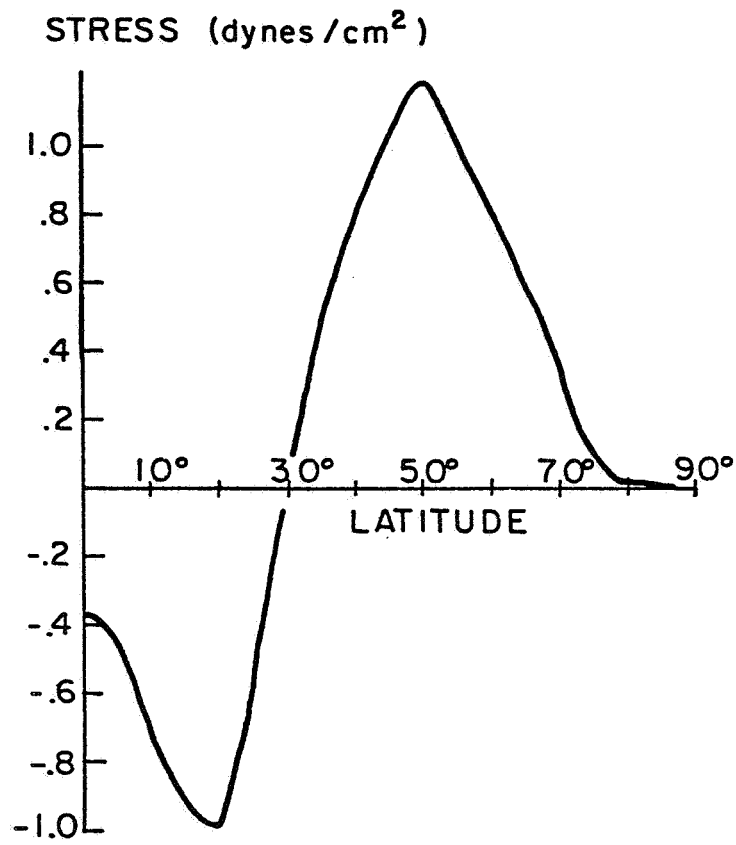

Fig. 6: Annually averaged surface heat flux and wind stress used to drive the uncoupled ocean experiments.

Case I: Heat flux driven ocean, and the effect of rotation

In our first experiment we studied the effect of rotation on an ocean driven only by heat flux. Figs.7a and b present the results after 7 months of integrating the model with *no stress*. In the case of Fig. 7a we also allowed for *no rotation*, setting the Coriolis parameter equal to zero. Without rotation there is a very strong meridional circulation, with a relatively small region of strong sinking motion at high latitudes, in agreement with Stommel's (1962) analysis. The maximum descending velocities of the order of 40 m day^{-1} are observed at 70° latitude, whereas upwelling occurs with velocities of less than a few meters per day. When the Coriolis force is included, the contrast is striking: rotation strongly inhibits meridional motion except at the Equator, where rings of water can move in the North-South direction without changing their radius of rotation. The result (Fig. 7b) is that the circulation is five orders of magnitude weaker, with maximum upwelling at the Equator ($w_{\text{max}} \sim 0.2 \text{ cm day}^{-1}$) and weaker descending motion elsewhere.

Case II: Wind stress and heat flux driven ocean

Longer time integrations show convergence after a time of the order of several decades. The steady state solution obtained after 60 years of integration corresponding to the case of *no wind stress* (but including rotation) is presented in Figs. 8a-c. Figures 9a-c correspond to the steady state solution obtained with both *heat flux* and *wind stress*.

For both stress conditions it was found that advection of relative momentum is negligible except in a very narrow region at the Equator. Therefore, the basic balance is

$$-fv \simeq \nu_{\text{v}} u_{\text{ZZ}} = \tau_{\text{z}}^{(\text{x})}/\rho_{\text{O}} \quad (3.1)$$

$$fu = \simeq p_{\phi}/\rho_{\text{O}}a, \text{ or, } fu_{\text{z}} \simeq g \rho_{\phi}/(\rho_{\text{O}}a) \quad (3.2)$$

From these equations we can derive the condition

$$0 = -f \int_{-H}^0 v \, dz \simeq (\tau_{\text{O}}^{(\text{x})} - \tau_{-H}^{(\text{x})})/\rho_{\text{O}} \quad (3.3)$$

and an expression for the meridional stream function:

$$\psi = -\tau_{\text{O}}^{(\text{x})}/\rho_{\text{O}} \cot\phi/2\Omega + \nu g \rho_{\phi}/(a \rho_{\text{O}} f^2) \quad (3.4)$$

The zonal flow consists of a barotropic component $u_{\text{O}}(\phi) = \tau_{\text{O}}^{(\text{x})}/\rho_{\text{O}} \sqrt{2/(f\nu)}$ which satisfies the constraint (3.3) on the bottom stress, and a baroclinic component satisfying (3.1) and (3.2). In the zero stress case, $u_{\text{O}} = 0$ and v is too small to advect ρ even in the upper boundary layer, so that the equilibrium temperature field is determined simply by diffusive equilibrium:

$$\kappa_{\text{H}}(\rho_{\phi} \cos\phi)_{\phi} / (a^2 \cos\phi) + \kappa_{\text{v}} \rho_{\text{ZZ}} = 0 \quad (3.5)$$

except at high latitudes, where convection takes place. Therefore, the maximum sea surface temperature is observed at the Equator, and the Pole to Equator temperature contrast is about 25°C .

In the finite stress case, the intensity of the circulation is two orders of magnitude stronger. There is intense upwelling at the Equator, inducing a boundary layer. As a result, the maximum surface temperature is only 11°C and occurs at 22° latitude. Away from the Equator there is upwelling or downwelling depending on the direction of the Ekman pumping. Fig. 10

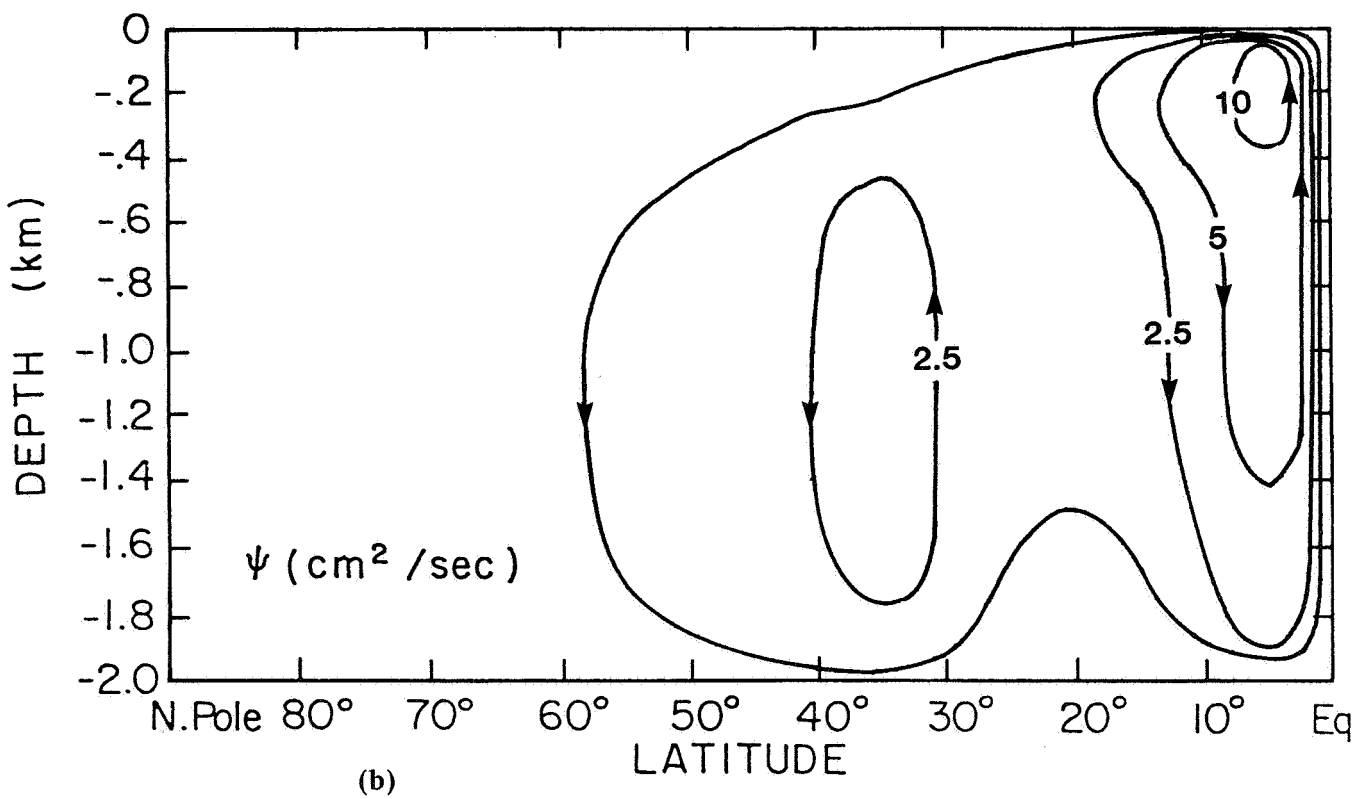
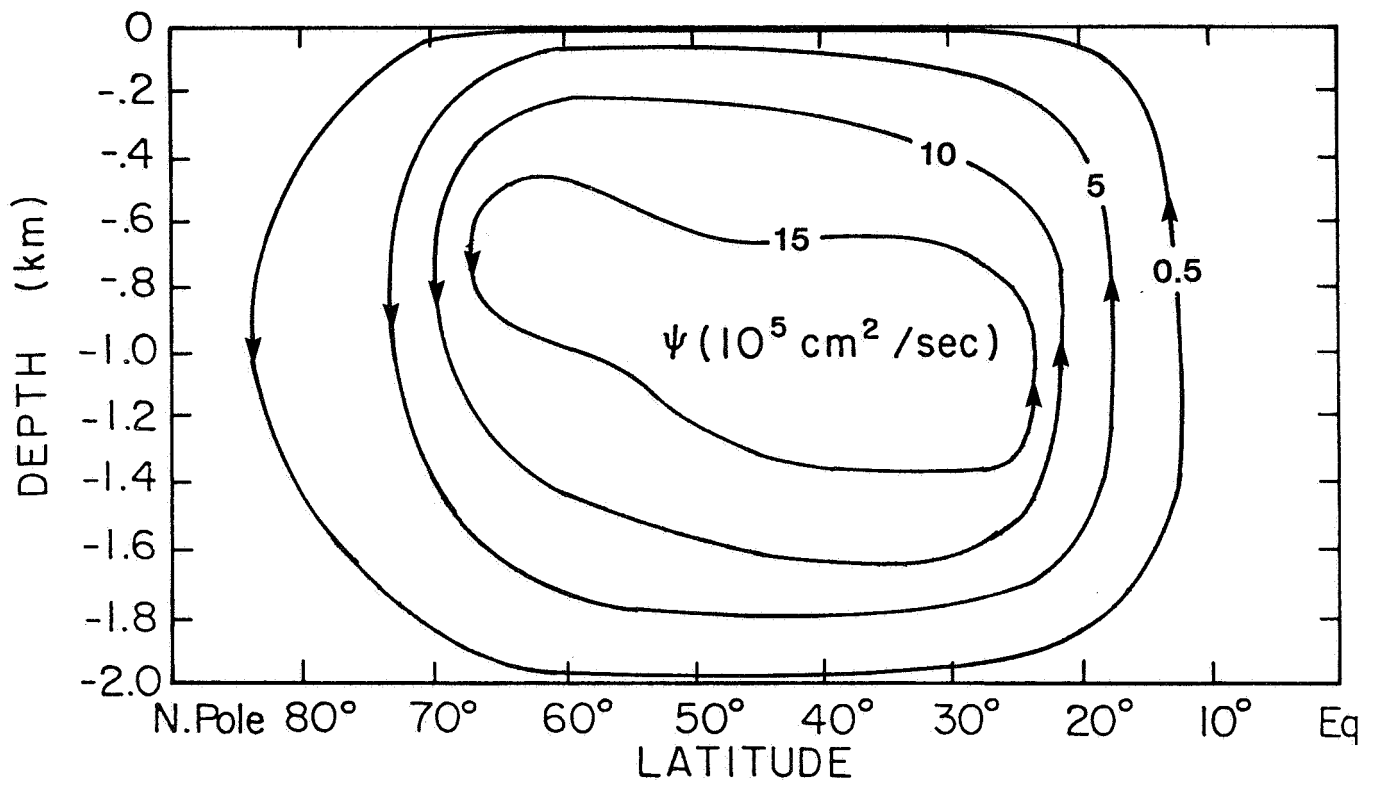

Fig. 7: Meridional mass stream function of the symmetric ocean model forced only by surface heat fluxes and no surface wind stress after 7 months of integration. a) with no planetary rotation; b) with rotation.

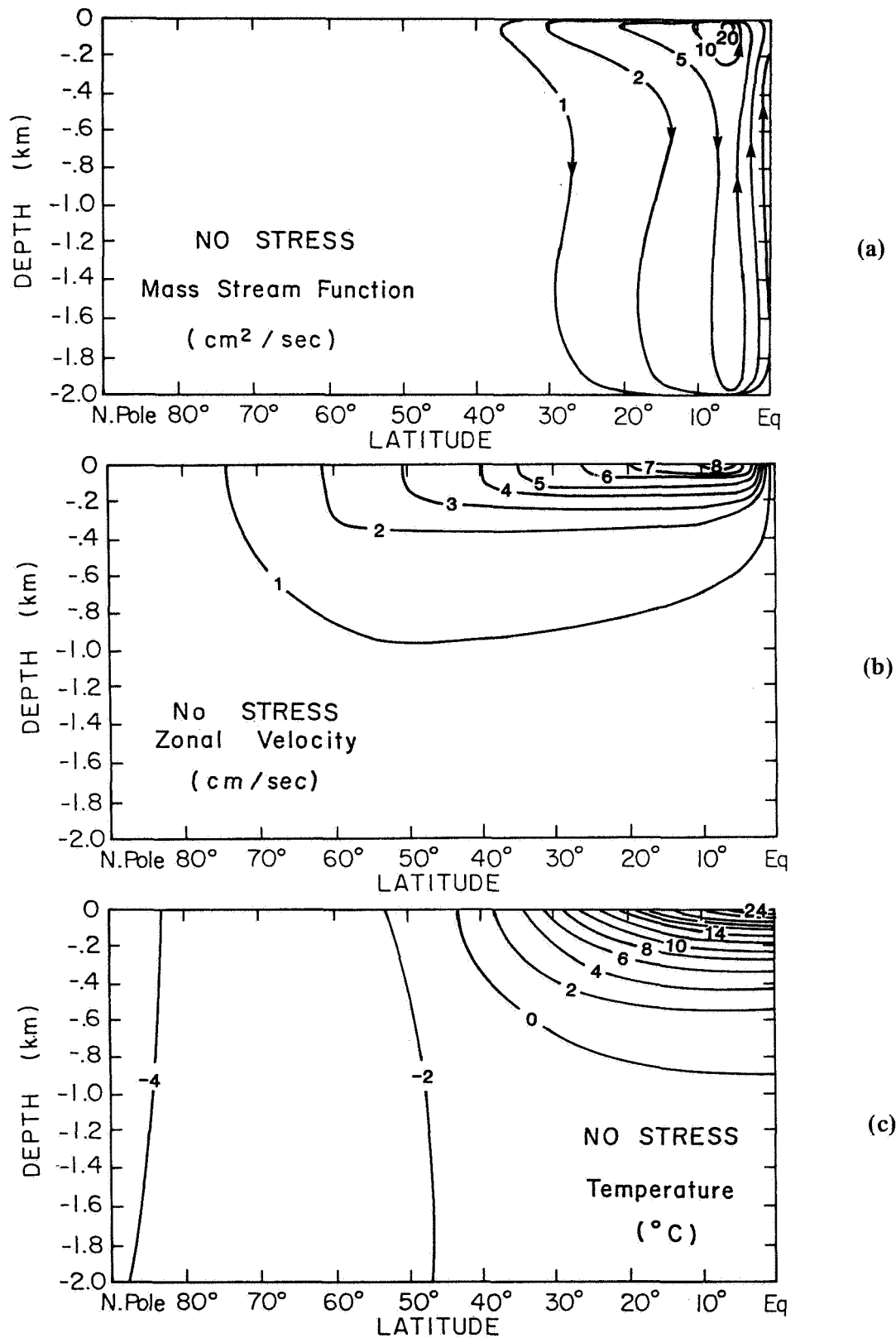

Fig. 8: Steady state ocean solution corresponding to a rotating ocean driven only by surface heat fluxes. a) meridional mass stream function; b) zonal velocity; c) temperature.

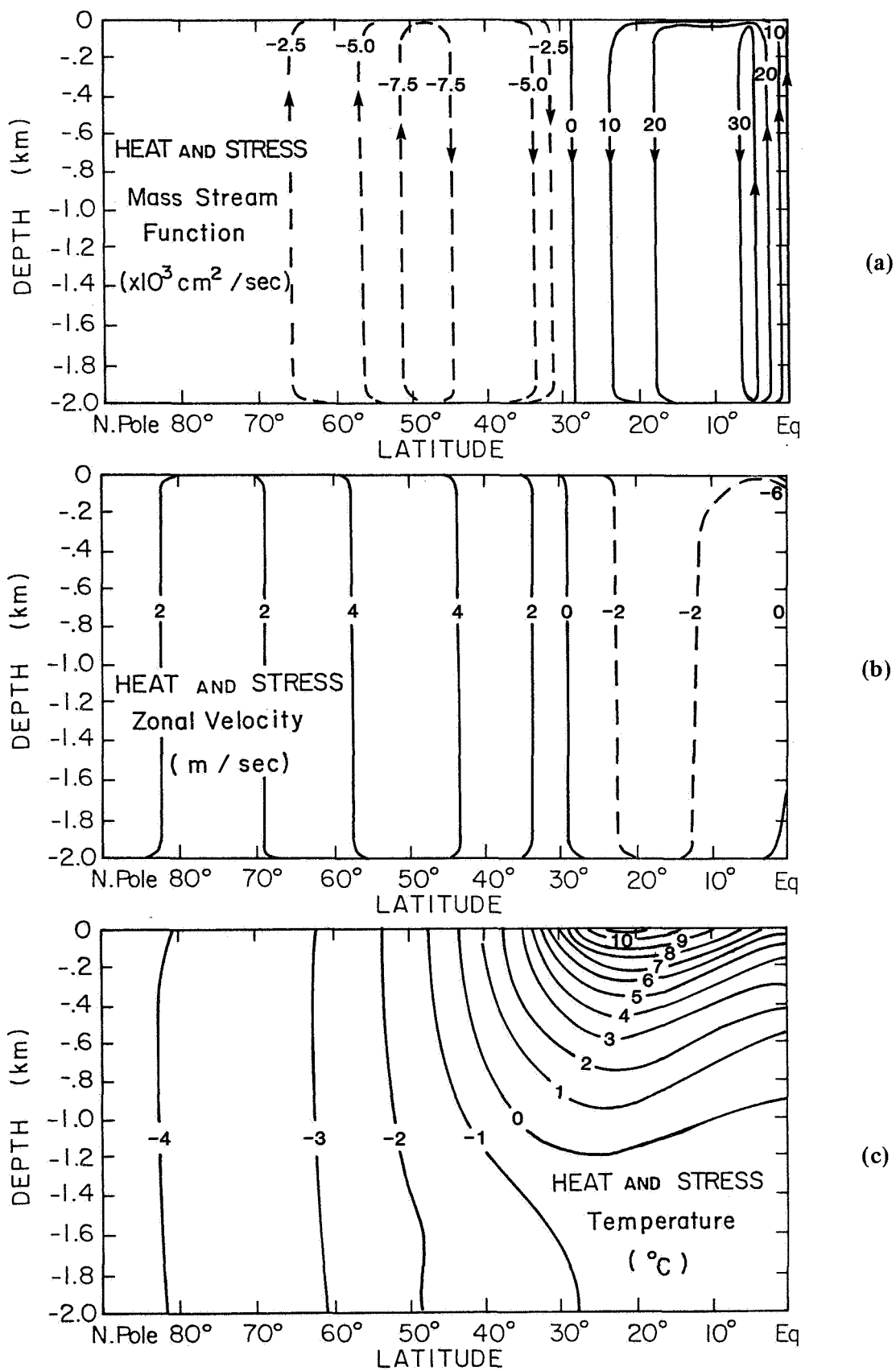

Fig. 9: Same as Fig. 8, but for the ocean driven by both surface wind stress and heat flux.

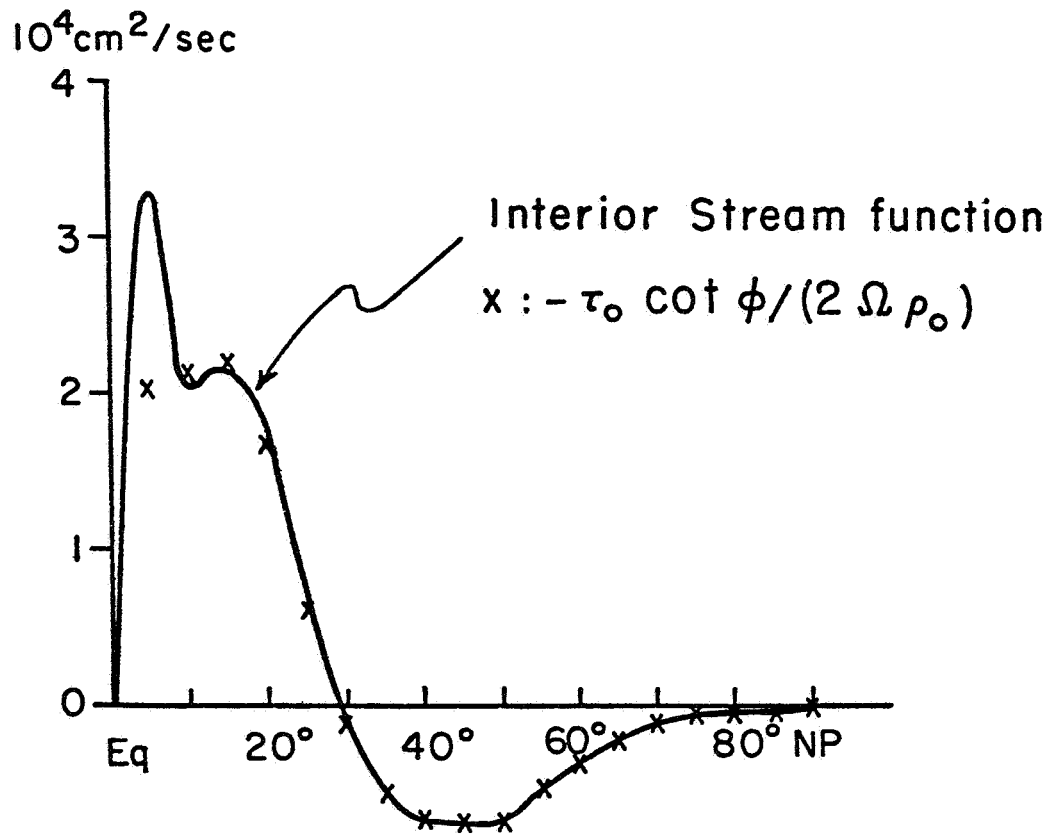

Fig. 10: Comparison of the interior modeled mass stream function (curve) and the stream function that would be expected for a symmetric model driven by wind stress only.

compares the interior stream function with the first term on the right hand side of (3.4), indicating that the circulation is indeed dominated by wind stress driving.

Poleward of 50° , in the region of maximum heat loss from the surface, vertical convection takes place. Cold water in mid and high latitudes is diffused equatorwards creating a pool of cold bottom water and weak temperature gradients. In both cases a weak thermocline structure exists equatorward of about 40° .

3.3 Coupled Ocean-Atmosphere Experiment

The coupled model was integrated with the sun at the Equator for about 4 months (atmosphere) and 25 years (ocean). A convergence zone developed initially at the Equator, inducing surface easterlies in the tropics with a minimum at the Equator. This in turn produced strong upwelling at the Equator, shifting the maximum sea surface temperatures to 8°N and S . After a few days of interaction two ITCZs developed at the latitudes of maximum sea surface temperatures and remained there during the rest of the integration (Figs. 11 a-c), producing downward motion in the equatorial troposphere. This pattern is similar to the double ITCZ with clear skies at the Equator observed during March (spring equinox in the Northern Hemisphere) over the Pacific Ocean (Kornfield *et al.*, 1967).

The model ocean temperature is far too cold in the tropics, which is at least partly due to the assumption of a constant expansion coefficient. It is also possible that the tendency of the GISS model to be overcast has reduced the overall equilibrium temperature of the coupled system. Nevertheless, the oceanic temperature distribution in the tropics is qualitatively similar to that observed in the Pacific (Reid, 1965, Fig. 2).

Even though the model boundary conditions are symmetric with respect to the Equator, the numerical solution indicates a noticeable difference between the northern and southern hemispheres, although less pronounced than in Case II of section 3.1.

In this experiment the atmospheric model failed to attain convergence after a few months of integration. The maximum oscillations were observed in the meridional stream function, with an amplitude of about 10% of the presented values and a period of a few days. The much smaller amplitude of the oscillations in this case compared to the fixed ocean experiments of Section 3.1, is probably due to the low tropical sea surface temperatures and consequently reduced occurrence of moist convection.

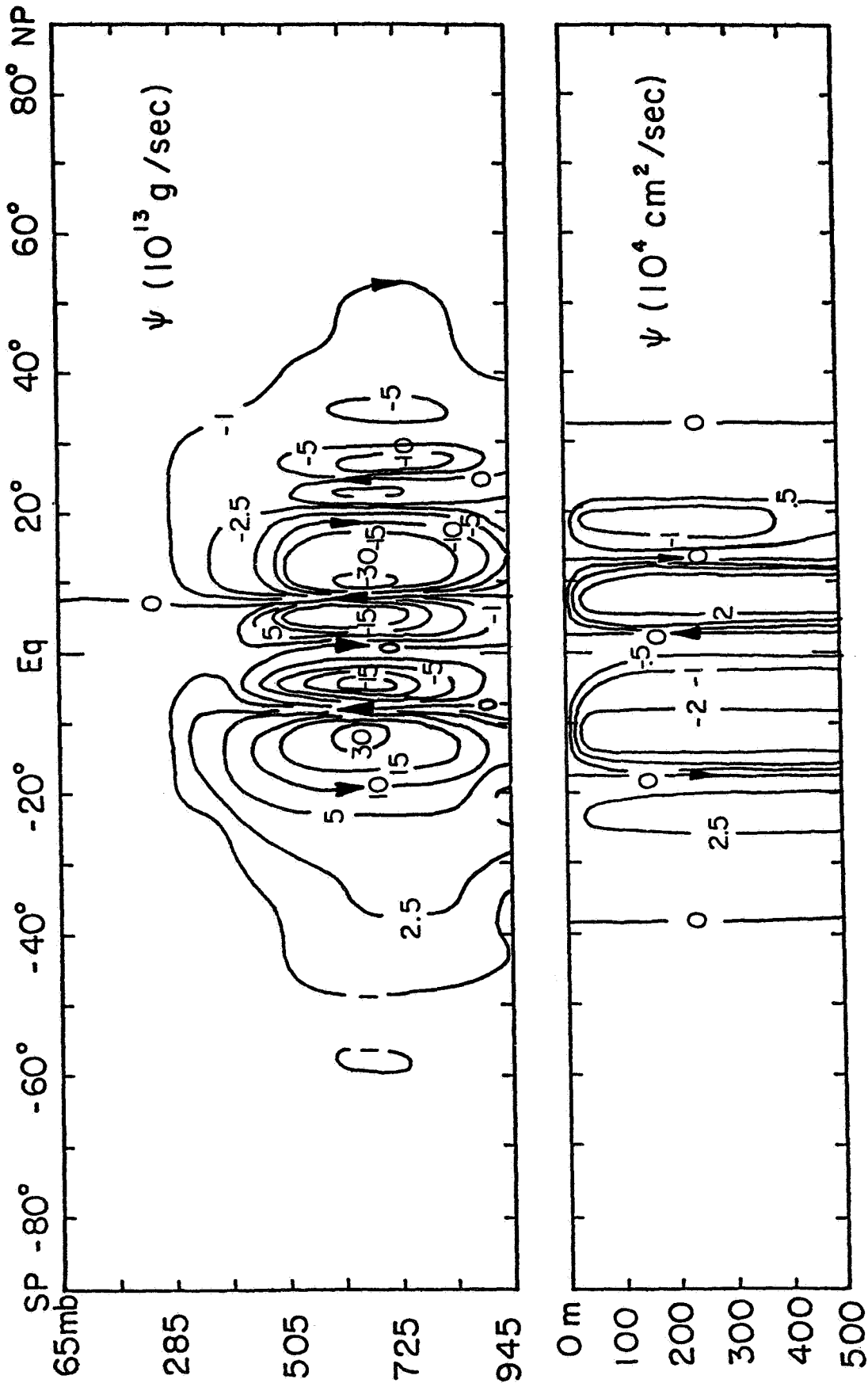

Fig. 11a: Time averaged coupled ocean-atmosphere solution corresponding to a permanent equinox integration. Top: atmospheric model. Bottom: ocean model. a) mass stream function.

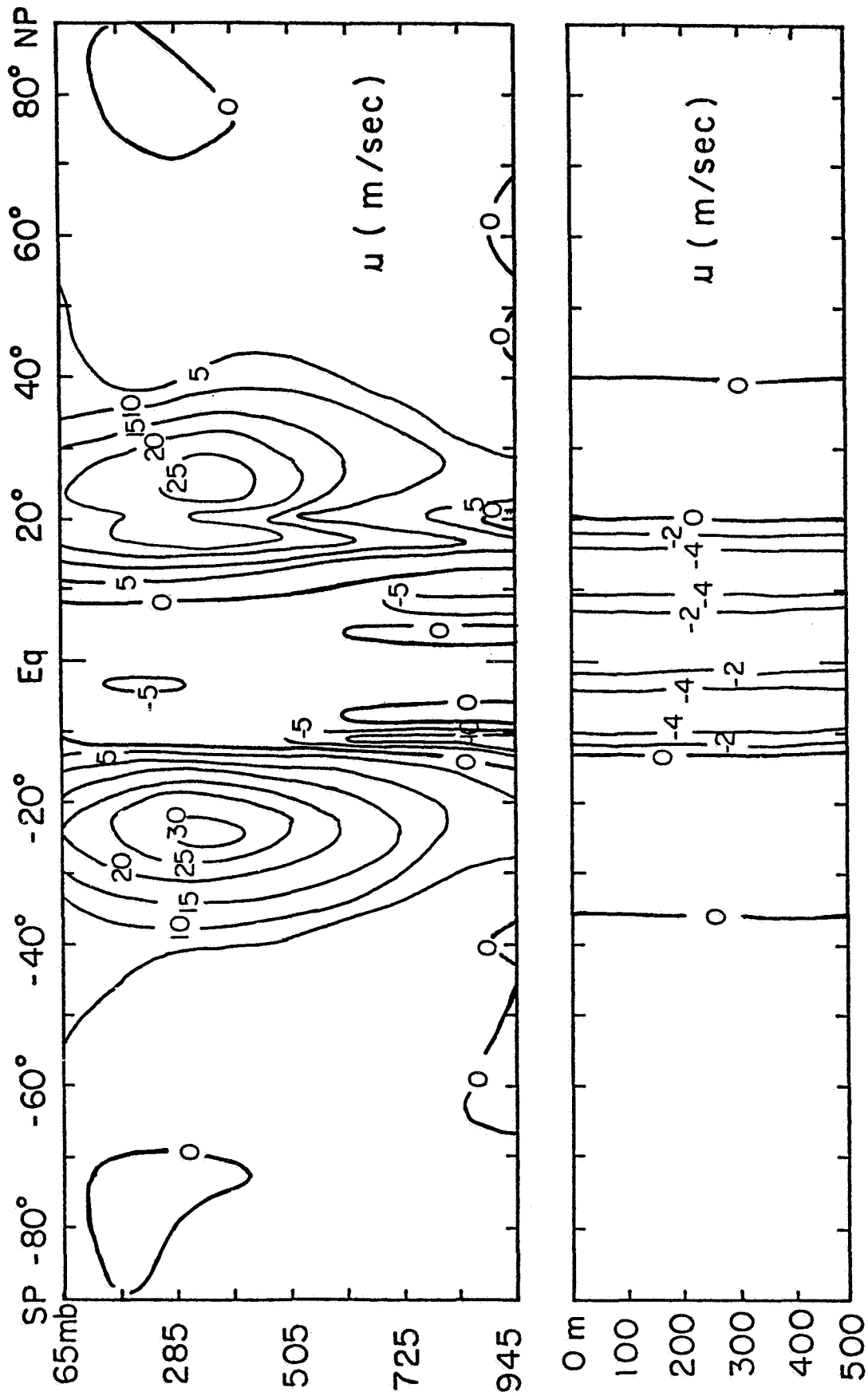

Fig. 11b: Time averaged coupled ocean-atmosphere solution corresponding to a permanent equinox integration. Top: atmospheric model. Bottom: ocean model. b) zonal velocity.

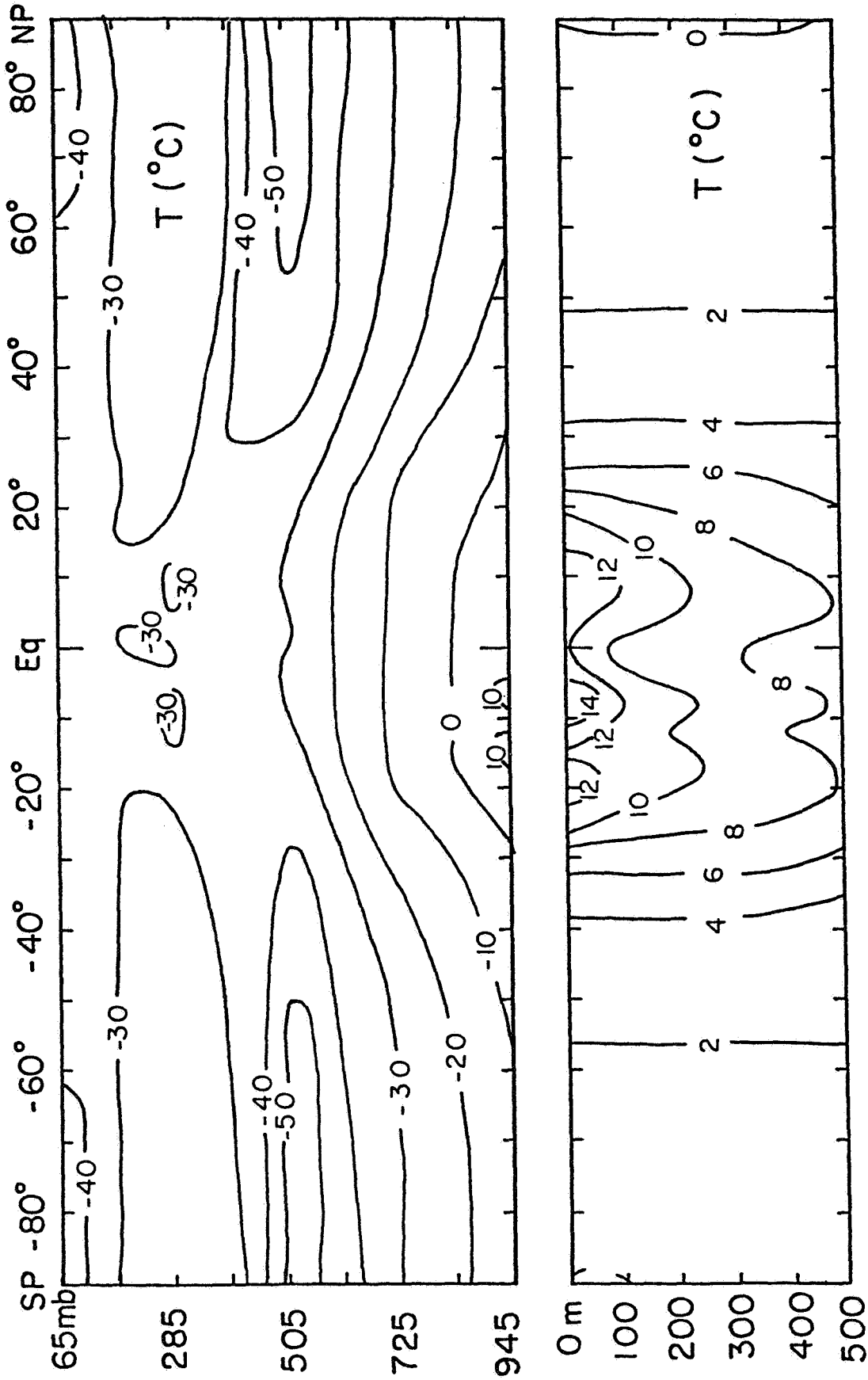

Fig. 11c: Time averaged coupled ocean-atmosphere solution corresponding to a permanent equinox integration. Top: atmospheric model. Bottom: ocean model. c) temperature.

References

- Charney, J.G., 1971: Tropical cyclogenesis and the formation of the intertropical convergence zone. *Mathematical problems in the geophysical sciences*, Vol. 13 of *Lectures in Applied Mathematics*. Published by the Am. Math. Soc., pp 355-368.
- Goswami, B.M., J. Shukla, E.K. Schneider, and Y.C. Sud, 1984: Study of the dynamics of the Intertropical Convergence Zone with a symmetric version of the GLAS climate model. *J. Atmos. Sci.*, *41*, 5-19.
- Kalnay-Rivas, 1973: Numerical models of the circulation of the atmosphere of Venus, *JAS*, *30*, 763-779.
- Kornfield, J., A. F. Hasler, K.J. Hanson, and V.E. Suomi, 1967: Photographic cloud climatology from ESSA III and V computer produced Mosaics. *Bull. Amer. Meteor. Soc.*, *48*, 878-883.
- Oort, A. and E.M. Rasmussen, 1970: On the annual variation of the monthly mean meridional circulation. *Mon. Wea. Rev.*, *98*, 423-442.
- Oort, A.H. and T.H. Von der Haar, 1976: On the observed annual cycle in the ocean-atmosphere heat balance over the Northern Hemisphere. *J. Phys. Oc.*, *6*, 781-800.
- Palmen, E. and Newton, C.W., 1969: *Atmosphere Circulation Systems*, Academic Press, New York.
- Schneider, E.K. and R.S. Lindzen, 1977: Axially symmetric steady state models of the basic state for instability and climate studies. Part I: Linearized calculations. *J. Atmos. Sci.*, *34*, 263-279.
- Schneider, E.K., 1977: Axially symmetric steady state models of the basic state for instability and climate studies. Part II: Nonlinear calculations. *J. Atmos. Sci.*, *34*, 280-296.
- Sommerville, R.C.J., P.H. Stone, M. Halem, J.E. Hansen, J.S. Hogan, L.M. Drugan, G. Russell, A.A. Lacis, W.J. Quirk and J. Tenenbaum, 1974: The GISS Model of the Global Atmosphere, *JAS*, *31*, 84-117.
- Thompson, R.O.R.Y., 1976: Climatological numerical models of the surface mixed layer of the ocean. *J. Phys. Oc.*, *6*, 496-503.

BIBLIOGRAPHIC DATA SHEET

1. Report No. NASA TM-86220	2. Government Accession No.	3. Recipient's Catalog No.	
4. Title and Subtitle A STUDY OF THE DYNAMICS OF THE ITCZ IN A SYMMETRIC ATMOSPHERE-OCEAN MODEL		5. Report Date June 1988	
		6. Performing Organization Code 611	
7. Author(s) J. G. Charney, E. Kalnay, E. Schneider, and J. Shukla		8. Performing Organization Report No. 87B0277	
9. Performing Organization Name and Address Laboratory for Atmospheres Goddard Space Flight Center Greenbelt, Maryland 20771 and Massachusetts Institute of Technology Cambridge, Massachusetts 02139		10. Work Unit No.	
		11. Contract or Grant No.	
		13. Type of Report and Period Covered Technical Memorandum	
12. Sponsoring Agency Name and Address National Aeronautics and Space Administration Washington, D.C. 20546		14. Sponsoring Agency Code	
15. Supplementary Notes Authors Schneider and Shukla are affiliated with the Department of Meteorology, University of Maryland, College Park, Maryland 20741. At time of presentation, all authors were affiliated with the Massachusetts Institute of Technology, Cambridge, Massachusetts. This paper was presented at the Joint IUTAM/IUGG Symposium on Monsoon Dynamics, New Delhi, India, December 5-9, 1977.			
16. Abstract A numerical model of the circulation of a coupled axisymmetric atmosphere-ocean system has been constructed to investigate the physical factors governing the location and intensity of the Inter-tropical Convergence Zone (ITCZ) over oceans and over land. The results of several numerical integrations are presented to illustrate the interaction of the individual atmospheric and oceanic circulations. It is shown that the ITCZ cannot be located at the Equator because the atmosphere-ocean system is unstable for lateral displacements of the ITCZ from an equilibrium position at the Equator. NOTE: This unfinished manuscript was written shortly after the Symposium on Monsoon Dynamics held in New Dehli, India in December of 1977. The work was not completed due to the lack of convergence of the solutions (of which only time averages are presented). The purpose of this TM is to make the results obtained at that time, which are still important for the understanding of the dynamics of the ITCZ, available to the scientific community.			
17. Key Words (Selected by Author(s)) Coupled ocean-atmosphere model Intertropical Convergence Zone Symmetric atmospheric model		18. Distribution Statement Unclassified-Unlimited Subject Category 47	
19. Security Classif. (of this report) Unclassified	20. Security Classif. (of this page) Unclassified	21. No. of Pages 20	22. Price* A02

**National Aeronautics and
Space Administration
Code NTT-4**

**Washington, D.C.
20546-0001**

**Official Business
Penalty for Private Use, \$300**

**BULK RATE
POSTAGE & FEES PAID
NASA
Permit No. G-27**



**POSTMASTER: If Undeliverable (Section 158
Postal Manual) Do Not Return**